

Diverter Tub Spout

Bec inverseur

Vertedor de bañera con cambiador

Product Specifications



TSPOUT-CP TSPOUT-BN TSPOUT-ORB

FEATURES

- Coordinates with Continental & Traditional Suites
- 1/2" -14 NPT Connection
- Slip Fit Tub Spout
- 100% Factory Pressure Tested

CARACTÉRISTIQUES

- Coordonné avec les ensembles Continental et Traditional
- Raccord NPT 1/2 po-14
- Bec à insertion rapide pour
- Pression vérifiée en usine- 100%

CARACTERÍSTICAS

- Coordina con las suites Continental y Traditional
- Conexión de 1/2" - 14 NPT
- Vertedor de encastre deslizante
- Probado en fábrica bajo presión al 100%

APPLICABLE STANDARDS/CODES

Specified model meets or exceeds the following:

NORMES ET CODES APPLICABLES

Le modèle spécifié est conforme aux normes suivantes ou les dépasse:

NORMAS Y ESTÁNDARES APLICABLES

El modelo especificado reúne o sobrepasa las siguientes condiciones

- ASME A112.18.1/CSA B125.1
- IAPMO/cUPC

AVAILABLE FINISHES / FINIS OFFERTS / DISTINTOS ACABADOS:

- Polished Chrome / Chrome poli / Cromo lustrado (CP)
- PVD Brushed Nickel / PVD Nickel brossé / PVD Níquel cepillado (BN)
- Oil Rubbed Bronze / Bronze poncé à l'huile / Bronce lustrado al aceite (ORB)



Contact your sales representative for more information or visit our website at mainlinecollection.com

Diverter Tub Spout

Bec inverseur
Vertedor de bañera con cambiador

Product Specifications



MAINLINE

TSPOUT-CP TSPOUT-BN TSPOUT-ORB

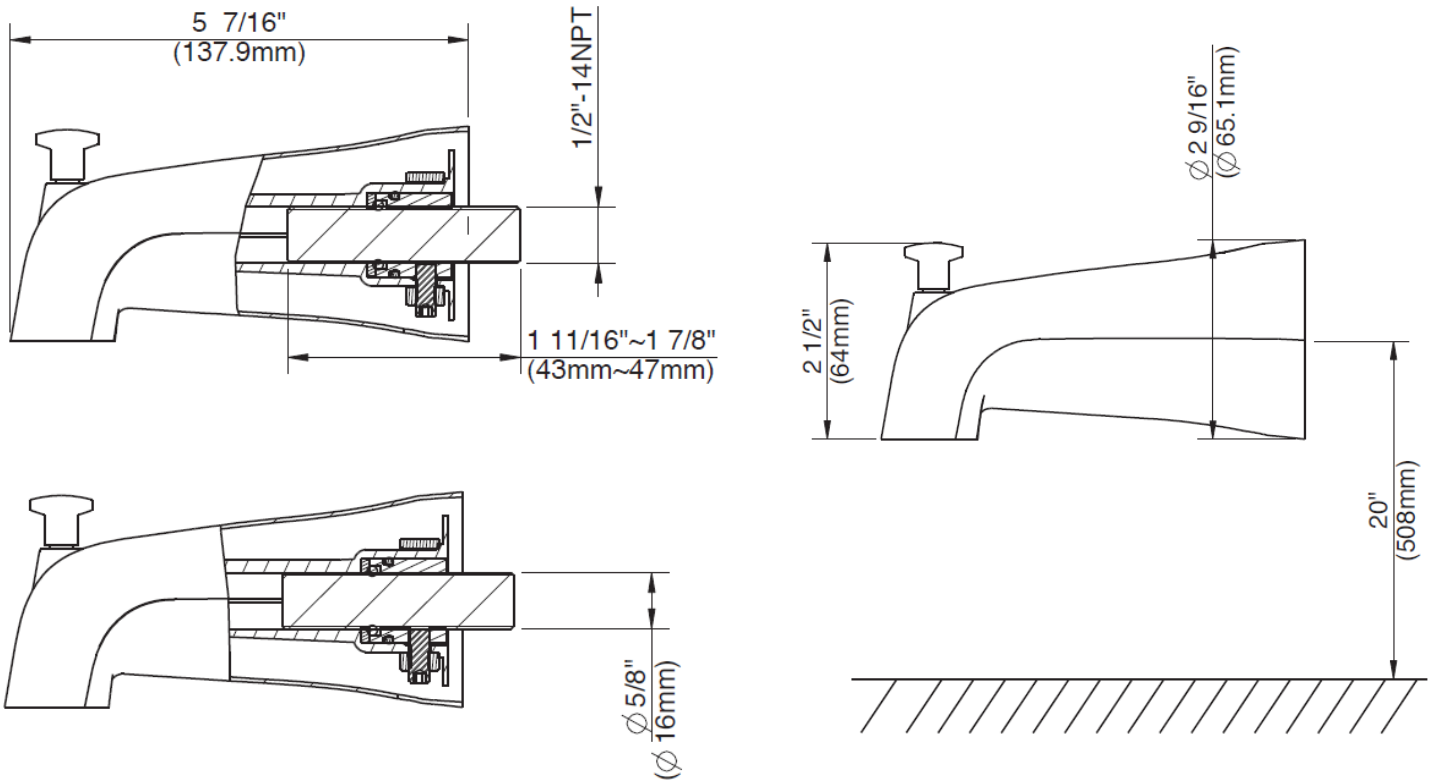

Contact your sales representative for more information or visit our website at mainlinecollection.com

Revised 9/2/2018