

SPECIFICATIONS

Features/Benefits

- Diverter on Tub Spout (D501028TC/D502028TC Only)
- Requires Gerber Treysta® Rough-In, G00GS50 Series (Horizontal Inputs) or G00GS52 Series (Vertical Inputs), Sold Separately
- Includes Treysta® Ceramic Disc Pressure Balance Cartridge
- Includes Surge® 4 1/2" 5 Function Showerhead, D462027 (1.75 gpm) or D460029 (2.0 gpm)
- 1.75 gpm (6.6 L/min) Max Flow @ 80 psi (D501028TC/D501528TC)
- 2.0 gpm (7.6 L/min) Max Flow @ 80 psi (D502028TC/D502528TC)
- 6" Metal Shower Arm
- 6" Tub Spout, D606467 (D501028TC/D502028TC Only)
- Finish-Matched Deep Wall Kit, D113001, Sold Separately
- Finish-Matched Shallow Wall Kit, GA663B11, Sold Separately



Available Color/Finishes

Color Description

 **Chrome**

Please see gerberonline.com or current price list for available finishes. Finish is defined by additional suffix.

Standards & Certifications



(Lever Handle)

Flow Rate

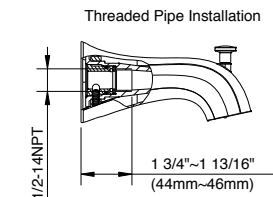
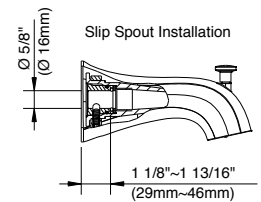
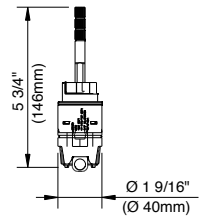
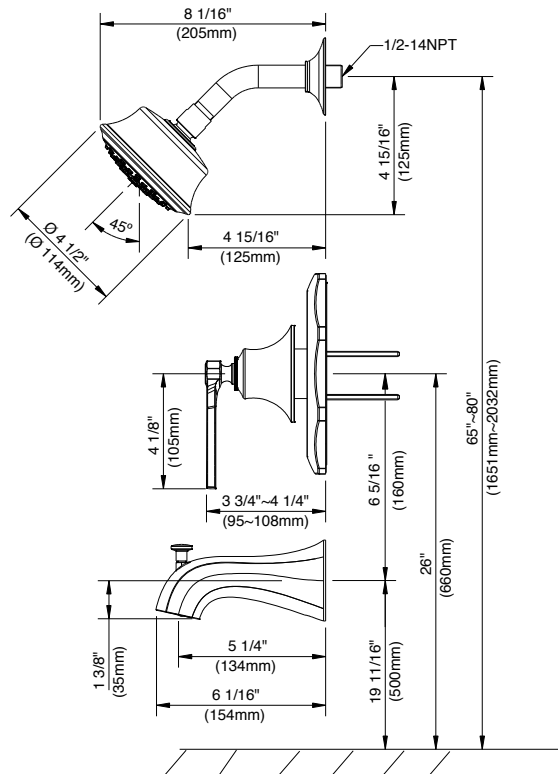
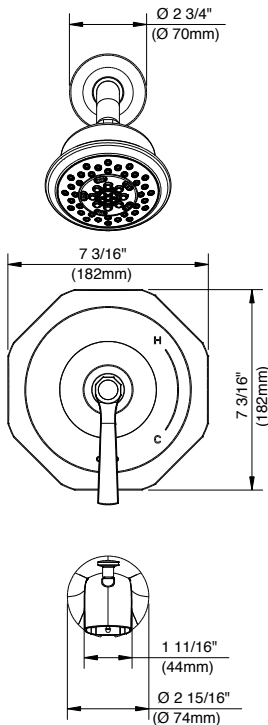
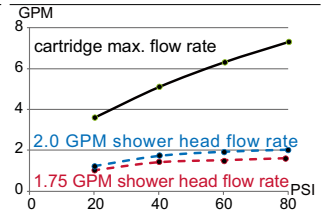

Submittal Information:

Name: _____ Contractor: _____
Location: _____ Contact #: _____